

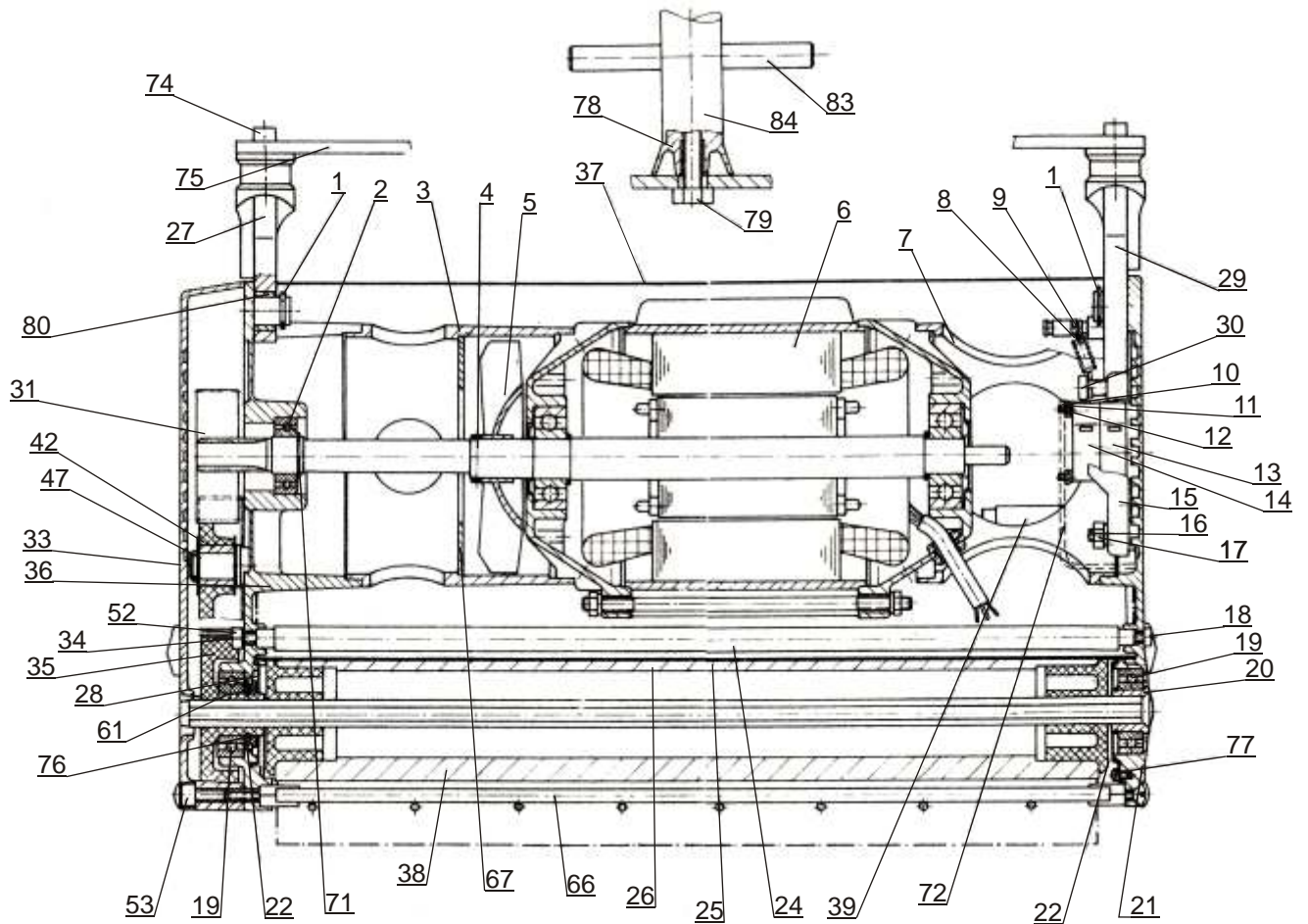

Ersatzteile - spare parts TM 3

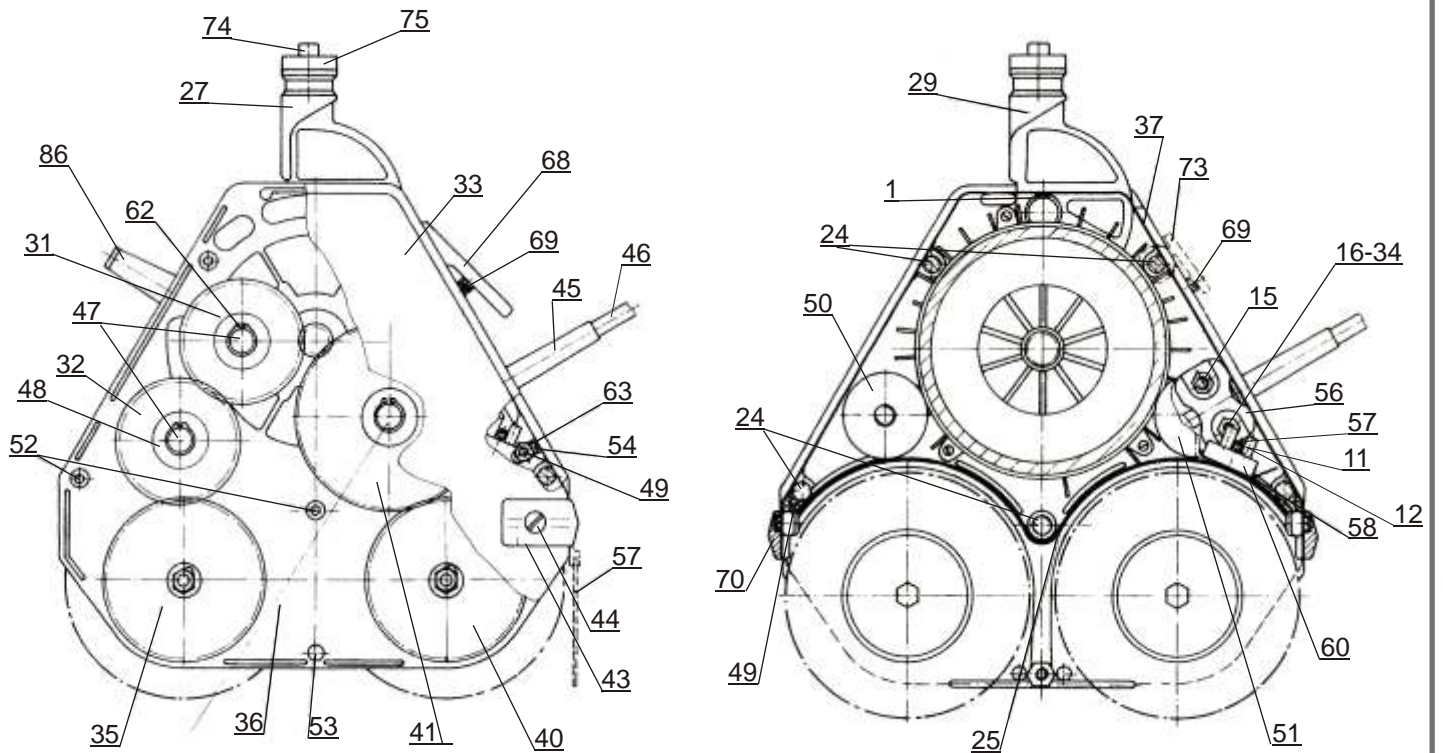

Ersatzteile - spare parts TM 3

Nr.	Bezeichnung	description	Nr	Bezeichnung	description
1	Sicherungsring A 12	Snapping A12	49	Zylinderschraube	Cylinder head screw
2	Kugellager 6002	Ballbearing 6002	50	Betriebskondensator	Run Capacitor
3	Zwischenstück G komplet	Distancepiece G	51	Anlaßkondensator	Start Capacitor
4	Spannstift 3 x 20 A2	Split pin 3 x 20 A2	52	Zylinderschraube M5 x 12	Cylinder head screw M5 x 45
5	Lüfterrad	Ventilator	53	Schraube M5 x 45	Screw M5 x 45
6	Motor	Motor RFB 18/2-7PR	54	Klemmbügel/-schiene	Clamp strip
7	Zwischenstück E	Distancepiece E	55	Haltefeder	Spring
8	Transportwagen	Trolley	56	Klemmbacke	Cable clamp
9	Zugfeder 10 x 1,2 x 64	Tension spring 10x1,2 x 64	57	Zylinderschraube M3 x 16	Cylinder head screw M3 x 16
10	Gewindestift M3 x 35	Grub screw M3 x 35	58	Drahthalteplatte	Wire fixing plate
11	Mutter M3 Ms	Nut M5	60	Klemmleiste	Terminal
12	Federring M3	Spring ring M3	61	V - Ring	V- ring
13	Mikroschalter	Microswitch	62	Doppelrolle	Wormscrew
14	Schaltteil komplet	Switchpart	63	Mutter M4	Nute M4
15	Gewindestift M5 x 25	Grub screw M5 x 25	64	Zahnscheibe M4 A2	Lock washer M4 A2
16	Mutter M5	Nut M5	66	Kabelfang	Cableprotector
17	Scheibe M5	Disc M5	68	Stielsperre	Handle stop
18	Zylinderschraube M5 x 12	Cylinder head screw	69	Feder für Stielsperre	Handle stop-spring
19	Kugellager 6003-2RS	Ballbearing 6003 - 2RS	70	Gummistoffdichtung	Grommet
20	Flansch	Flange	71	Sicherungsring A15	Snapping A15
21	Gehäuseblock E	Housing unit E cpl.	72	Schalterabdeckung USA	Switchcover
22	Sprengling A 17	Retainingring A 17	74	Stielansatz Oberteil	Handle connector upper part
23	Fadenschutz	Protective plat	75	Flachstange	Flatbar
24	Zugstange TM3	Motorstud	76	Anlaufscheibe	Washer disc
25	Bürstenabdeckung	Brushcover	77	Schraube M3 x 5	Screw M3 x 5
26	Steckachse	Brush axle	78	Zugschnäpper	Snap-in
27	Stielansatz Unterteil G	Handle connector lower part G	79	Stiel Oberteil	Handle, upper part
29	Stielansatz Unterteil E	Handle connector lower part E	80	Lagerbuchse	Bearing
30	Schraube M6 x 16	Srew M6x16	81	Rollenhebel	Rollerlever
31	Zahnrad 48 rechts	Gear 48 right	82	Rollenhebelhalterung	Rollerleverholder
32	Zahnrad 48 links	Gear 48 left	83	Querrohr	Cross bar
33	Getriebedeckung	Gearcover	84	Stielknoten links komplet	T-piece left cpl.
34	Fächerscheibe M5	Lockwasher M 5	95	Federring M6	Spring ring M6
35	Zahnrad 66 rechts	Gear 66 right	96	Schraube M6 x 30	Screw M6 x 30
36	Gehäuseblock G	Housing unit E cpl.	109	Isolierplättchen	Isolating plate
37	Haube elox.	Cover	116	Zylinderschraube	Cylinder head screw
39	Motorschutzschalter	Thermorelay	117	Linsensenk. M5 x 12	Screw M5 x 12
40	Zahnrad 66 links	Gear 66 left	118	Sicherungsring A10	Snapping A10
41	Zahnrad 73 rechts	Gear 76 right	121	Zylinderschraube M5 x 12	Cylinder head screw
42	Kugellager 6000	Ballbearing 6000	122	Stielunterteil	Handle, lower part
45	Tülle	Grommet	123	Stielunterteil	Handle, upper part
46	Kabel, 10m	Cable Schuko 10m	124	Stielknoten rechts komplet	Handle connector right, cpl.
47	Lagerbolzen	Bearingpin	125	Zugentlastung	Tension reducer
48	Paßscheibe	Disc	126	Kabelhalter rechts	Cableholder right

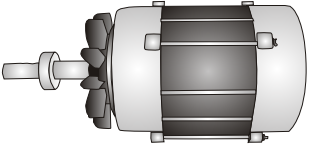
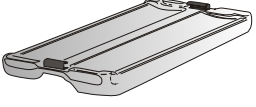
Ersatzteile - spare parts TM 3

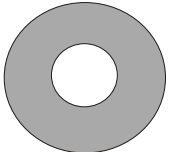
<p>E 1</p>  <p>16 mm</p>	<p>E 3</p> 	<p>E 4</p>  <p>20 mm</p>	<p>E 5</p> 
<p>Sicherungsring A 12 Snapping A 12</p>	<p>Zwischenstück G Distancepiece G</p>	<p>Spannstift 3 x 20 A2 Split pin 3 x 20 A2</p>	<p>Lüfterrad Ventilator</p>
<p>E 6</p> 	<p>E 7</p> 	<p>E 8_3</p> 	<p>E 10</p>  <p>30 mm</p>
<p>Motor RBF 0,18/2-PR Motor RBF 0,18/2-PR</p>	<p>Zwischenstück E Distancepiece E</p>	<p>Transporttasse komplett Trolley</p>	<p>Gewindestift M3 x 35 Grub screw M3 x 35</p>
<p>E 11</p> 	<p>E 12</p> 	<p>E 13_L</p> 	<p>E 13</p> 
<p>Mutter M3 Ms Nut M3 Ms</p>	<p>Federring M3 Spring Ring M3</p>	<p>Microschalter mit Rollenhebel Microswitch with Rollerlever</p>	<p>Microschalter Microswitch</p>
<p>E 14</p> 	<p>E 15</p> 	<p>E 16</p> 	<p>E 17</p> 
<p>Schalthebel komplett Switchpart</p>	<p>Gewindestift M5 x 25 Grub screw M5 x 25</p>	<p>Mutter M5 Nut M5</p>	<p>Scheibe M5 Disc M5</p>

Ersatzteile - spare parts TM 3

<p>E 18</p> 	<p>E 20</p> 	<p>E 21</p> 	<p>E 22</p> 
<p>Zylinderschraube M5 x 12 Cylinder head screw M5 x 12</p>	<p>Flansch Flange</p>	<p>Gehäuseblock G komplett Housing unit G complet</p>	<p>Sicherungsring A 17 Retainingring A 17</p>
<p>E 23</p> 	<p>E 24_3</p> 	<p>E 25_3</p> 	<p>E 26_3</p> 
<p>Fadenschutz Protective plat</p>	<p>Zugstange Motorstud</p>	<p>Bürstabdeckung Brushcover</p>	<p>Steckachse Brush axle</p>
<p>E 27</p> 	<p>E 29</p> 	<p>E 30</p> 	<p>E 31</p> 
<p>Stielansatz Unterteil G Handle connector lower part G</p>	<p>Stielansatz Unterteil E Handle connector lower part E</p>	<p>Schraube M6 x 16 Srew M6 x 16</p>	<p>Zahnrad 48 rechts Gear 48 right</p>
<p>E 32</p> 	<p>E 33</p> 	<p>E 34</p> 	<p>E 35</p> 
<p>Zahnrad 48 links Gear 48 left</p>	<p>Getriebedeckel Gearcover</p>	<p>Zahnscheibe M5 Lock washer M5</p>	<p>Zahnrad 66 rechts Gear 66 right</p>

Ersatzteile - spare parts TM 3

E 36

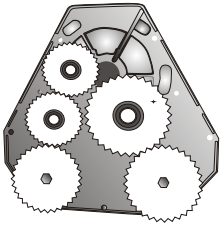

Gehäuseblock G komplett
Housing unit G cpl.

E 37_3

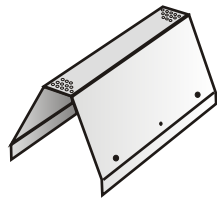

Motorhaube
motor cover

E 39

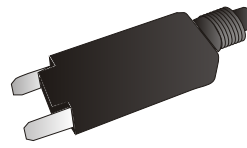

Motorschutzschalter
Thermorelay

E 40

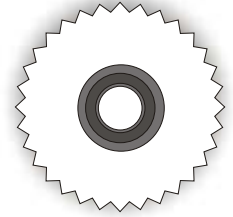

Zahnrad 66 links
Gear 66 left

E 41

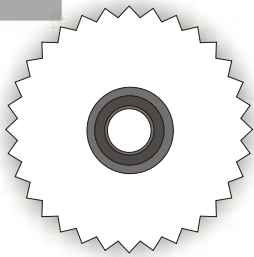

Zahnrad 73 rechts
Gear 73 right

E 45

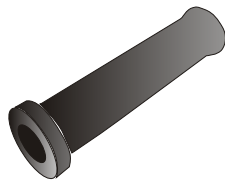

Tülle
Grommet

E 46



Kabel Schuko 10m
Cable Schuko 10m

E 47

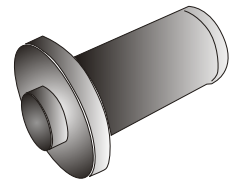

Lagerbolzen
Bearingpin

E 48



Paßscheibe
Disc

E 49

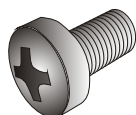

Zylinderschraube
Cylinder head screw

E 50

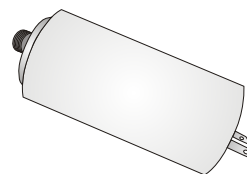

Betriebskondensator 8muF
Run Capacitor 8muF

E 51

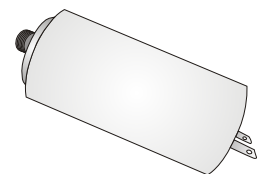

Anlaßkondensator 10 uF
Start Capacitor 10 uF

E 52

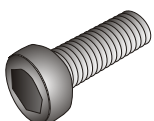

Schraube M5 x 12
Srew M5 X 12

E 53

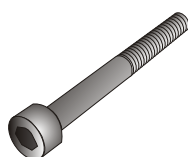

Schraube M5 x 45
Screw M5 x 45

E 54

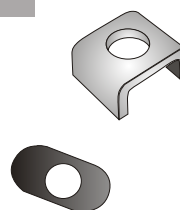



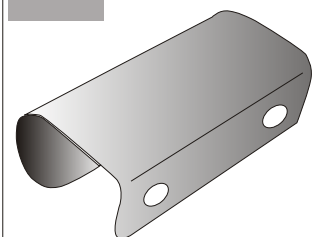

Klemmschiene
Clamp strip

E 55

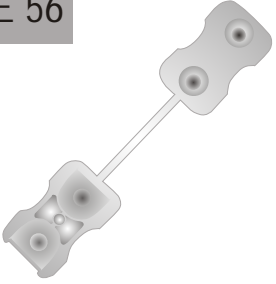
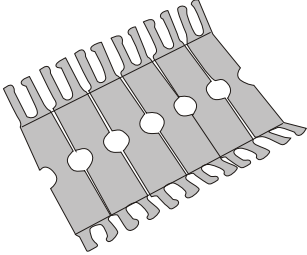
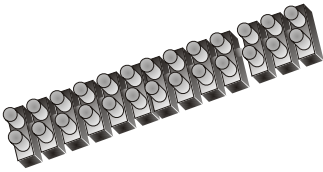
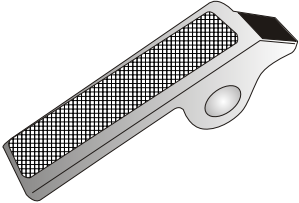

Haltefeder
Spring

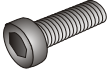
Ersatzteile - spare parts TM 3

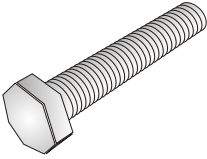
<p>E 56</p> 	<p>E 57</p> 	<p>E 58</p> 	<p>E 60</p> 
<p>Klemmbacke Cable clamp</p>	<p>Zylinderschraube M3 x 16 Cylinder head screw M3 x 16</p>	<p>Drahthalteplatte Wire fixing plate</p>	<p>Klemmleiste EKL 1 Terminal</p>
<p>E 61</p> 	<p>E 63</p> 	<p>E 66_3</p> 	<p>E 68</p> 
<p>V-Ring</p>	<p>Mutter M4 Nut M4</p>	<p>Kabelfang Cable protector</p>	<p>Stielsperre Alu Handle stop</p>
<p>E 69</p> 	<p>E 70</p> 	<p>E 71</p> 	<p>E 74</p> 
<p>Feder für Stielsperre Handle stop - spring</p>	<p>Gummidichtung Grommet</p>	<p>Sicherungsring Snapring</p>	<p>Schraube M3 x 5 Screw M3 x 5</p>
<p>E 75_3</p> 	<p>E 77</p> 	<p>E 78</p> 	<p>E 79</p> 
<p>Flachstange Flatbar</p>	<p>Schraube M3 x 5 Screw M3 x 5</p>	<p>Stielknoten T-piece</p>	<p>Schraube M3 x 5 Screw M3 x 5</p>

Ersatzteile - spare parts TM 3

E 83_3



Tragbolzen
Cross bar

E 84



Einhandstielunterteil
Handle, lower part

E 85



Einhandstieloberteil
Handle, upper part

E 88



Stiel komplett

E 126

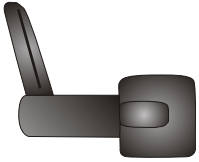

Kabelhaken
Cable holder